

SPECIFICATION

产品规格书

REFOND P/N 产品型号

RF-A3E35-2W2E-B1

R&D 研发

Mass Production 量产供货

Contents 目录

1. Description 产品介绍.....	3
1.1 General Description 产品描述.....	3
1.2 Features 产品特征.....	3
1.3 Application 产品应用.....	3
1.4 Package Dimension 封装尺寸.....	4
1.5 Product Parameters 产品参数.....	5
1.6 Bin Range Of Forward Voltage and Luminous Flux ($I_F=150\text{mA}$)电压与流明分 BIN 范围($I_F=150\text{mA}$).....	7
1.7 Typical Optical Characteristics Curves 典型光学特性曲线.....	9
2. Packaging 产品包装.....	14
2.1 Packaging Specification 包装规格.....	14
2.1.1 Carrier Tape Dimension 载带尺寸.....	14
2.1.2 Reel Dimension 卷盘尺寸.....	14
2.1.3 Label Form Specification 标签规格.....	15
2.1.4 Part number nomenclature describe 产品型号描述.....	15
2.2 Moisture Resistant Packing 防潮包装.....	16
2.3 Cardboard Box 包装纸箱.....	16
3. SMT Reflow Soldering Instructions SMT 回流焊说明.....	17
3.1 SMT Reflow Soldering Instructions SMT 回流焊说明.....	17
4. Handling Precautions 产品使用注意事项.....	19
4.1 Handling Precautions 产品使用注意事项.....	19

1. Description 产品介绍

1.1 General Description 产品描述



The White +Amber LED, which was fabricated by using blue chips and the phosphor.

Product Package: 3.56mmX3.70mmX0.75mm.

该产品为白光+琥珀光 LED，是由蓝光芯片激发荧光粉而形成，产品尺寸：
3.56mmX3.70mmX0.75mm。

1.2 Features 产品特征

- ▶ EMCPackage. EMC封装
- ▶ Extremely wide viewing angle. 发光角度大
- ▶ Suitable for all SMT assembly and solder process. 适用于所有的SMT组装和焊接工艺
- ▶ Available on tape and reel. 适用于载带及卷轴
- ▶ Moisture sensitivity level: Level 2. 防潮等级 Level2
- ▶ RoHS compliant. 满足RoHS要求
- ▶ Qualifications: The product qualification test plan is based on the guidelines of AEC-Q102 Stress Test Qualification for Automotive Grade Discrete Semiconductors 资格：产品资格测试计划基于 AEC-Q102 汽车级分立半导体应力测试资格准则

1.3 Application 产品应用

- ▶ Automotive Lighting Interior and Exterior. 汽车内部和外部照明

1.4 Package Dimension 封装尺寸

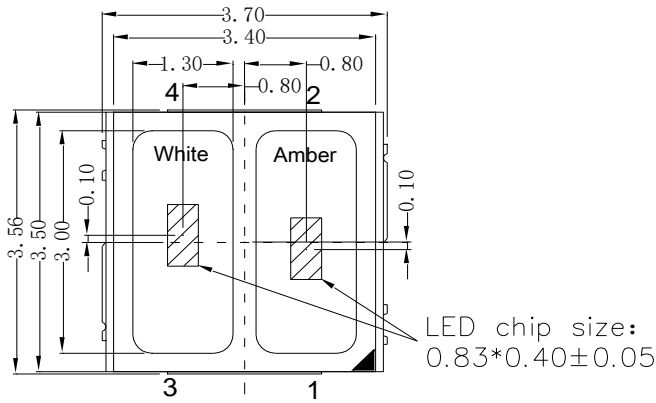

Fig.1-1 Top View 正面视图



Fig.1-2 Side View 侧面视图

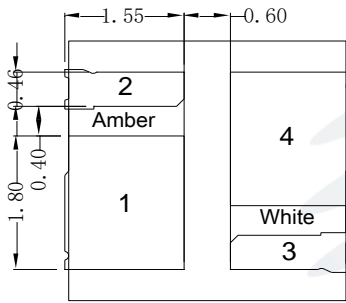

Fig.1-3 Bottom View 背面视图

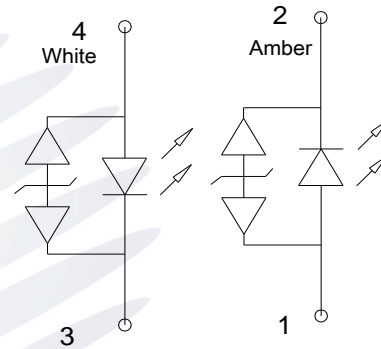

Fig.1-4 Polarity 极性

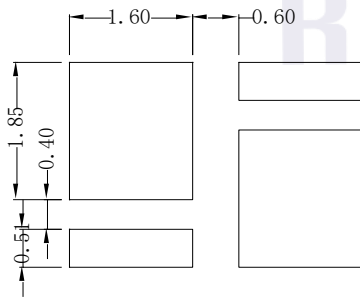

Fig.1-5 Soldering Patterns 推荐焊盘

Item 项目	Description 内容
chip 芯片	GaN
Package materials 包装材质	Heat-Resistant Polymer 耐热聚合物
Encapsulate Resin materials 封装树脂材质	Silicone Resin (with diffuser and phosphor) 硅树脂 (有扩散剂+荧光粉)
Electrodes materials 封装材质	Au-plated Copper Alloy 铜合金+镀金工艺

Notes 备注:

- All dimensions units are millimeters. 所有尺寸标注单位为毫米
- All dimensions tolerances are $\pm 0.10\text{mm}$ unless otherwise noted. 除特别标注外, 所有尺寸公差为 ± 0.10 毫米

1.5 Product Parameters 产品参数

Table 1-1 Electrical / Optical Characteristics at Ts=25°C 电性与光学特性

Item 项目	Symbol 符号	Test Condition 测试条件	White白光			Unit 单位	
			Min. (最小值)	Typ. (典型值)	Max. (最大值)		
Forward Voltage (正向电压)	V_F	$I_F=150mA$	2.80	3.05	3.40	V	
Forward Current (正向电流)	I_F	$T_s=25^\circ C$	15	150	200	mA	
Reverse Current (反向电流)	I_R	$V_R=5V$	---	---	10	μA	
Chromaticity Coordinate (色度坐标)	X	---	$I_F=150mA$	0.3288	---	---	
	Y	---	$I_F=150mA$	0.3415	---	---	
Luminous Flux (光通量)	Φ	$I_F=150mA$	55.3	69	75.3	lm	
Viewing Angle (发光角度)	2 θ 1/2	$I_F=150mA$	---	120	---	deg	
Thermal Resistance(Junc tion to Solder). (热阻)	Real	$R_{th JS real}$	$I_F=150mA$	---	25	34	$^\circ C/W$
	Electrical	$R_{th JS el}$	$I_F=150mA$	---	16	22	$^\circ C/W$
Item 项目	Symbol 符号	Test Condition 测试条件	Amber琥珀光			Unit 单位	
			Min. (最小值)	Typ. (典型值)	Max. (最大值)		
Forward Voltage (正向电压)	V_F	$I_F=150mA$	2.80	3.05	3.40	V	
Forward Current (正向电流)	I_F	$T_s=25^\circ C$	15	150	200	mA	
Reverse Current (反向电流)	I_R	$V_R=5V$	---	---	10	μA	
Chromaticity Coordinate (色度坐标)	X	---	$I_F=150mA$	0.563	---	---	
	Y	---	$I_F=150mA$	0.425	---	---	
Luminous Flux (光通量)	Φ	$I_F=150mA$	40.9	48	55.3	lm	
Viewing Angle (发光角度)	2 θ 1/2	$I_F=150mA$	---	120	---	deg	
Thermal Resistance(Junc tion to Solder). (热阻)	Real	$R_{th JS real}$	$I_F=150mA$	---	27	36	$^\circ C/W$
	Electrical	$R_{th JS el}$	$I_F=150mA$	---	19	25	$^\circ C/W$

Table 1-2 Absolute Maximum Ratings at Ts=25°C 绝对最大值

Parameter (参数)	Symbol (符号)	Value (值)	Unit (单位)
Power Dissipation (功耗)	P _D	1360	mW
Forward Current (正向电流)	I _F	200	mA
Peak Forward Current (峰值电流)	I _{FP}	350	mA
Reverse Voltage (反向电压)	V _R	5	V
ESD(耐受电压) (HBM,Class 3B)	V _{ESD}	8000	V
Operating Temperature (操作温度)	T _{OPR}	-40 ~ +125	°C
Storage Temperature (储存温度)	T _{STG}	-40 ~ +125	°C
Junction Temperature (结温)	T _J	150	°C

Notes 备注:

- 1/10 Duty cycle, 10ms pulse width. 脉宽10ms,占空比1/10。
- The above forward voltage measurement allowance tolerance is $\pm 0.05V$. 以上所示电压测量误差 $\pm 0.05V$ 。
- The above color coordinates measurement allowance tolerance is ± 0.005 . 以上所示坐标测量误差 ± 0.005 。
- The above luminous intensity measurement allowance tolerance $\pm 5\%$. 上述发光强度的测试允许公差为 $\pm 5\%$ 。
- Care is to be taken that power dissipation does not exceed the absolute maximum rating of the product. 使用功率不能超过规定的最大值。
- All measurements were made under the standardized environment of Refond. 所有测试都是基于瑞丰现有的标准测试平台。
- When the LEDs are in operation the maximum current should be decided after measuring the package temperature, junction temperature should not exceed the maximum rate. LED使用的最大电流需要根据散热条件确定, 结温不能超过最大值。
- At 25°C, pulse mode test, white photoelectric conversion efficiency $\eta_e=36\%$; amber photoelectric conversion efficiency $\eta_e=30\%$.在 25°C下, 脉冲模式测试, 白光光电转换效率为 36%; 琥珀光电转换效率为 30%。
- Thermal resistance values (R_{th JS real}) measure current is 150mA, Temperature constant at 25°C. 热阻值 (R_{th JS real})测试电流为 150mA, 测试温度恒定为 25°C。
- According to IEC62471, Photobiological Risk is Group 0. 根据 IEC62471 定义, 光生物危害为风险等级 0。

1.6 Bin Range Of Forward Voltage and Luminous Flux ($I_F=150\text{mA}$) 电压与流明分BIN 范围($I_F=150\text{mA}$)

Table 1-3 VF and Flux Bin Range 电压与流明分Bin范围

Item(项目)		Unit (单位)	I_F (电流)			V	150mA
Forward Voltage (电压)		G0	H0	I0			
		2.8-3.0	3.0-3.2	3.2-3.4			
Luminous Flux (流明)	White	PA	PB	QA	lm		
		55.3-61.2	61.2-67.8	67.8-75.3			
	Amber	NB	OA	OB			
		40.9-45.3	45.3-50	50.0-55.3			

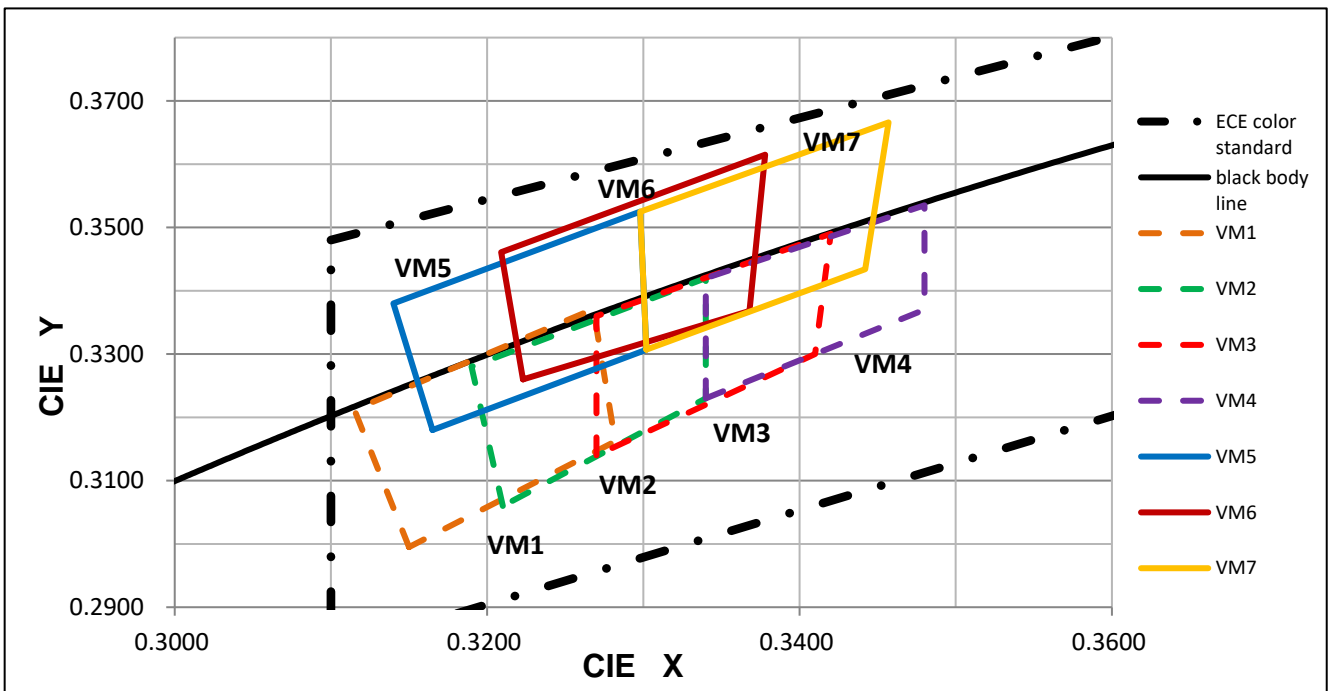

Fig. 1-6 The C.I.E Chromaticity Diagram (White)CIE色度图 (白光)

Table 1-4Color Bin Range 色区范围

BIN CODE	CIE-X1	CIE-Y1	CIE-X2	CIE-Y2	CIE-X3	CIE-Y3	CIE-X4	CIE-Y4
VM1	0.3150	0.2995	0.3115	0.3212	0.3268	0.3371	0.3282	0.3162
VM2	0.3210	0.3060	0.3190	0.3280	0.3340	0.3420	0.3340	0.3230
VM3	0.3270	0.3140	0.3270	0.3360	0.3420	0.3490	0.3410	0.3300
VM4	0.3340	0.3230	0.3340	0.3420	0.3480	0.3535	0.3480	0.3370
VM5	0.3165	0.3180	0.3140	0.3380	0.3298	0.3525	0.3302	0.3307
VM6	0.3223	0.3260	0.3209	0.3461	0.3378	0.3615	0.3368	0.3368
VM7	0.3302	0.3307	0.3298	0.3525	0.3457	0.3666	0.3442	0.3434

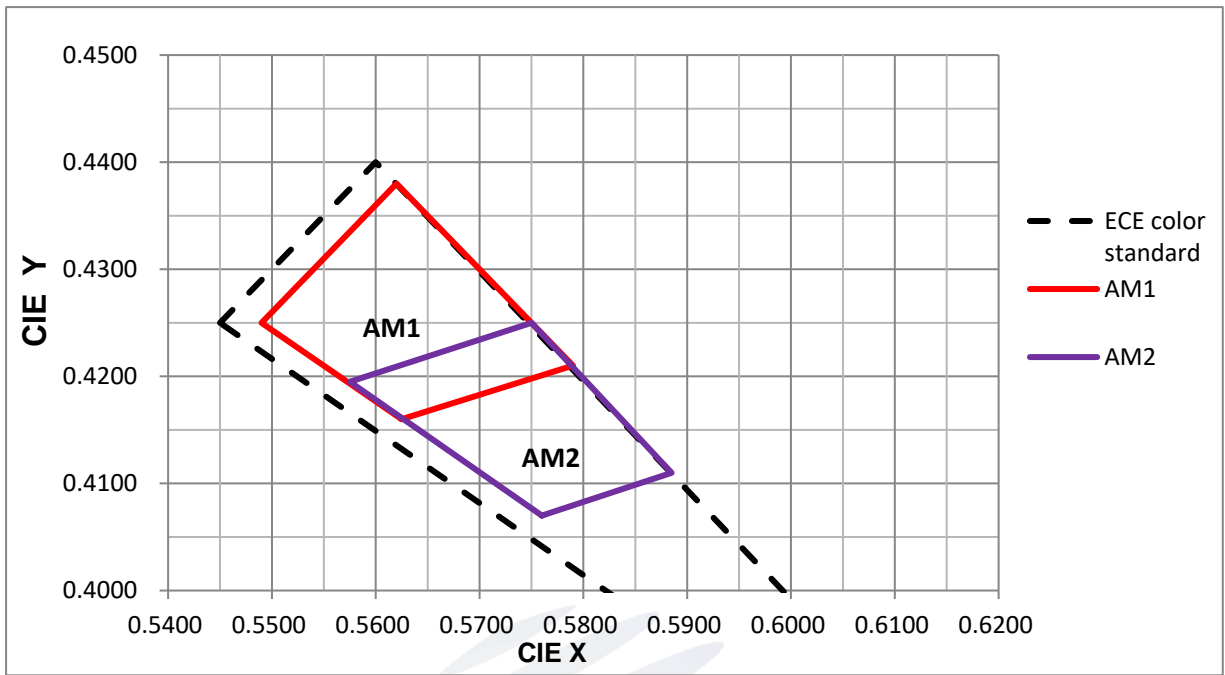

Fig. 1-6 The C.I.E Chromaticity Diagram (Amber) CIE色度图 (琥珀光)

Table 1-4 Color Bin Range 色区范围

BIN CODE	CIE-X1	CIE-Y1	CIE-X2	CIE-Y2	CIE-X3	CIE-Y3	CIE-X4	CIE-Y4
AM1	0.5625	0.4160	0.5490	0.4250	0.5620	0.4380	0.5790	0.4210
AM2	0.5760	0.4070	0.5575	0.4195	0.5750	0.4250	0.5885	0.4110



1.7 Typical Optical Characteristics Curves 典型光学特性曲线

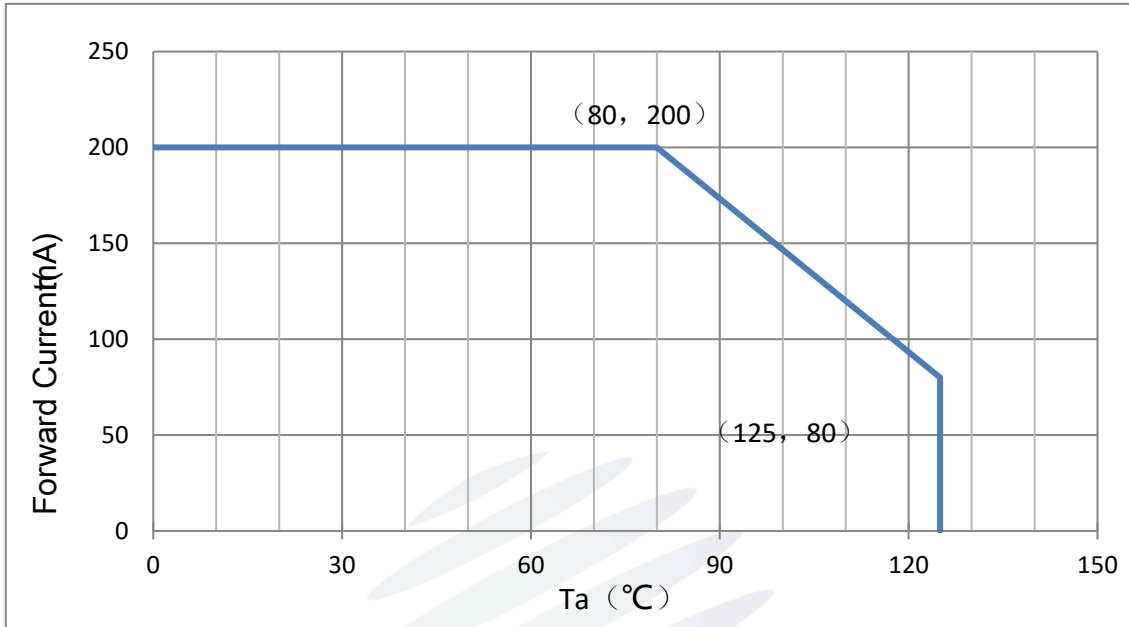

Fig.1-7 Ambient Temperature vs Allowable Forward Current 环境温度与正向电流特性曲线

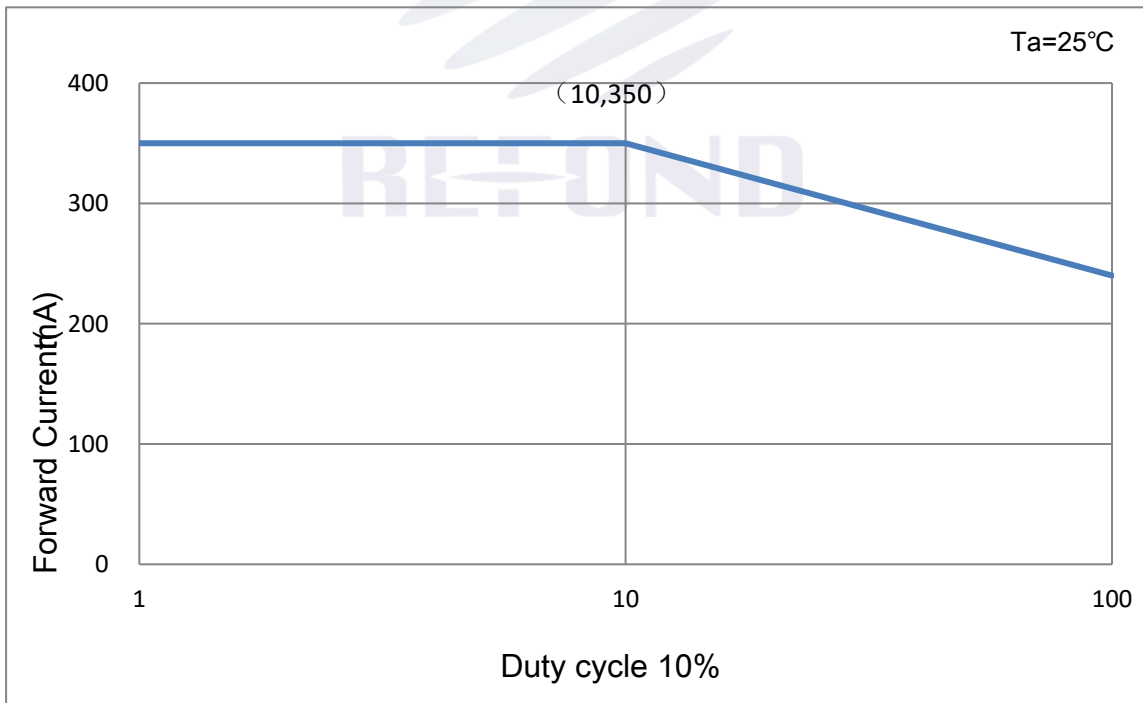

Fig.1-8 Duty cycle (10%) vs Allowable Forward Current 占空比与正向电流特性

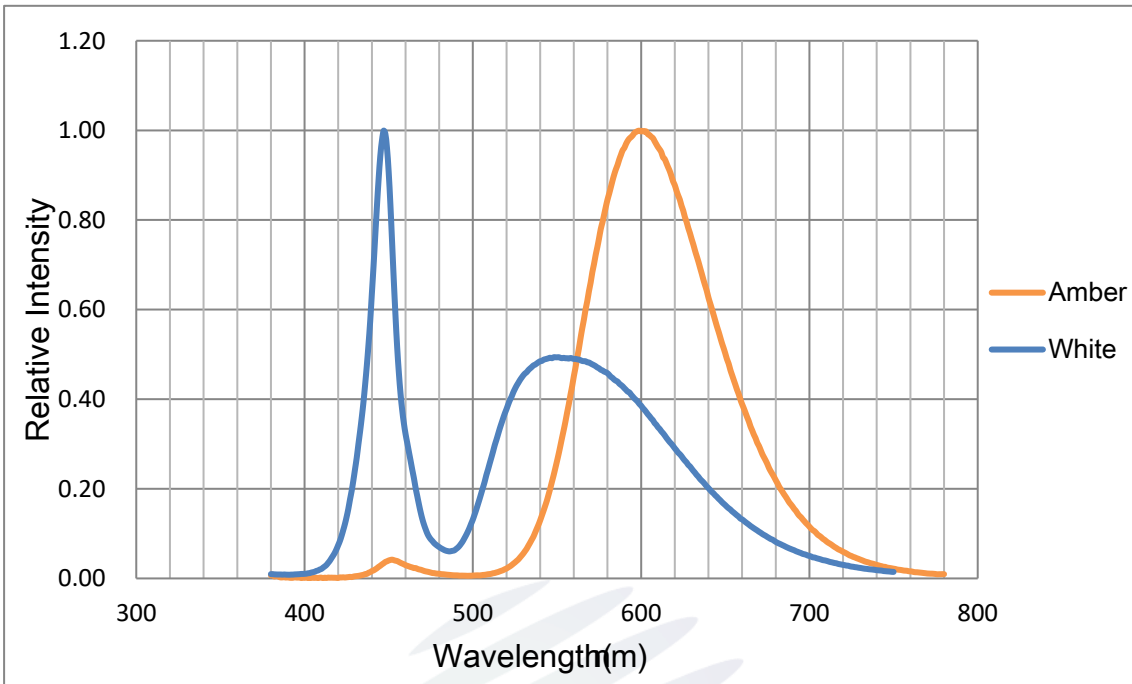

Fig.1-10 Spectrum Distribution 光谱分布特性曲线

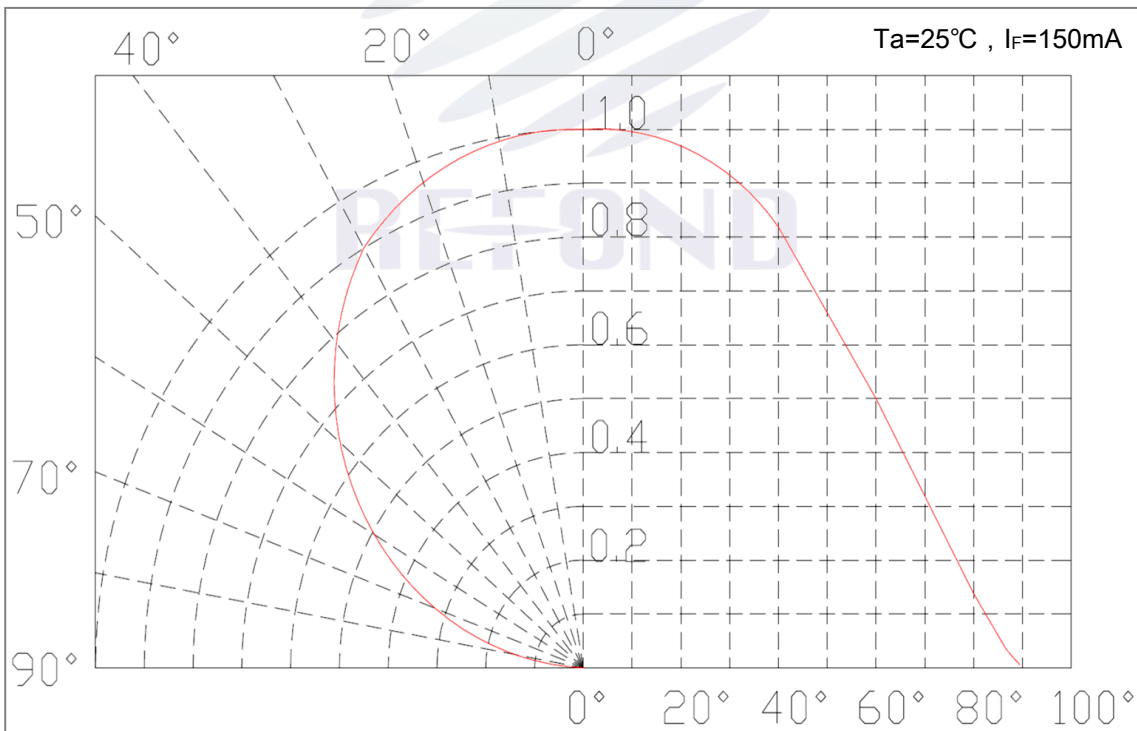

Fig.1-11 Radiation diagram 辐射特性曲线

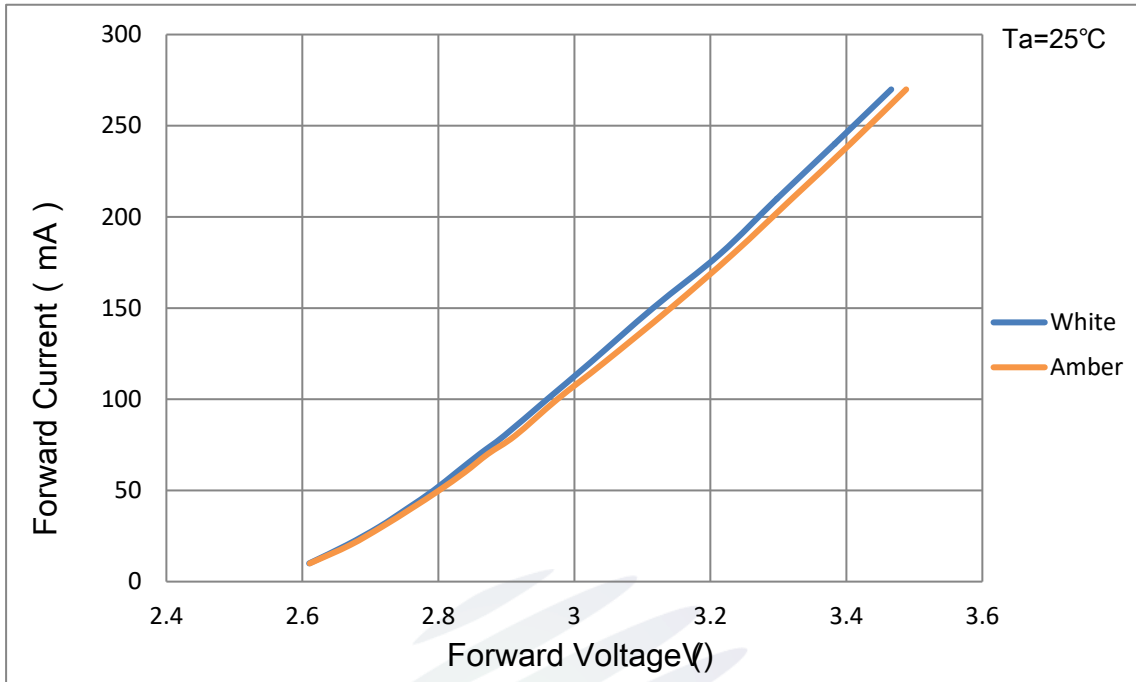

Fig.1-12 Forward Voltage Vs Forward Current 伏安特性曲线

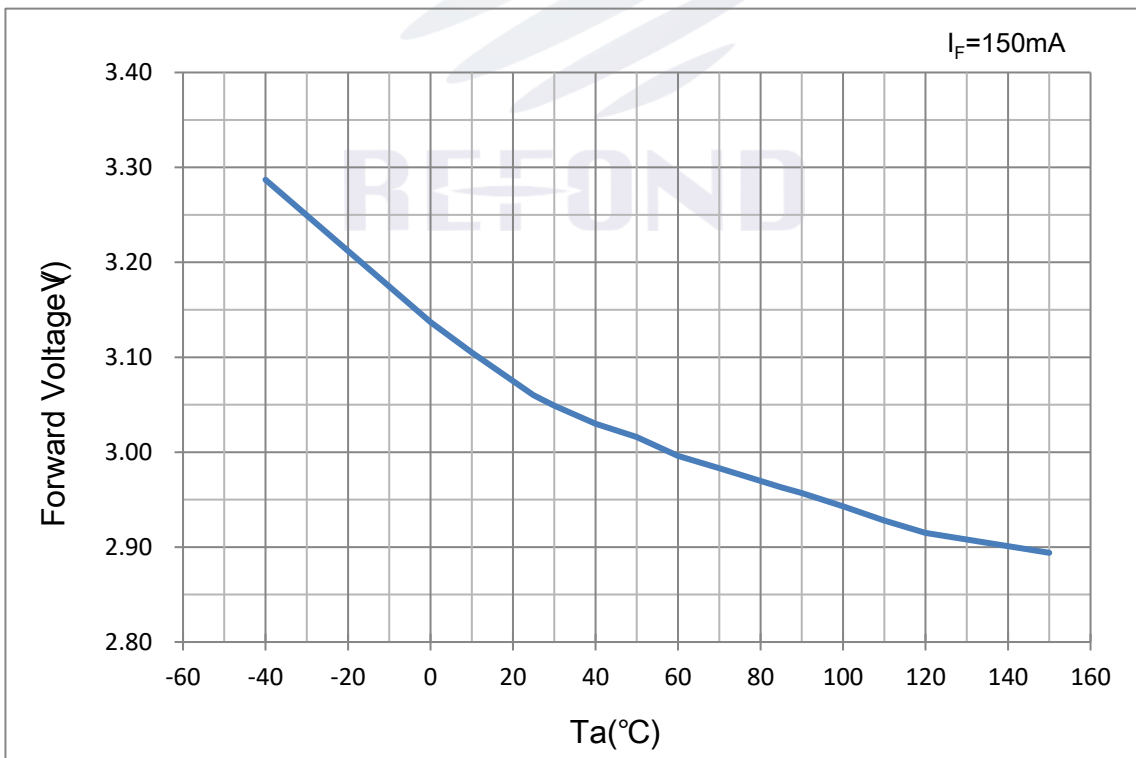

Fig.1-13 Forward Voltage Vs Ambient Temperature 电压与环境温度特性曲线

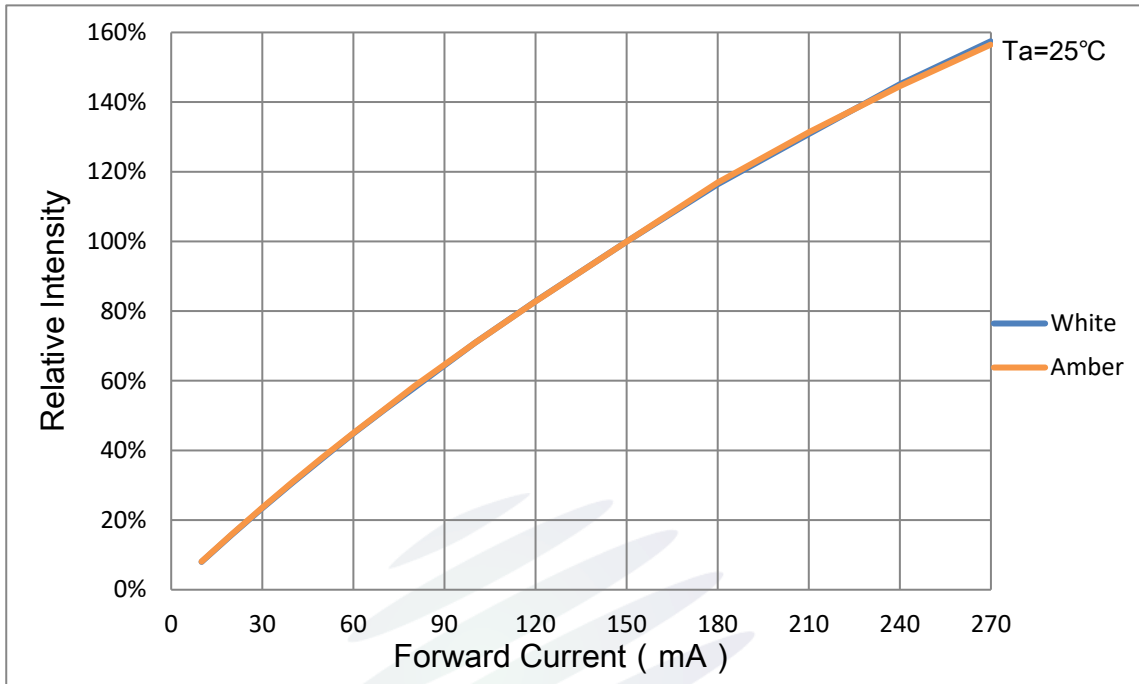

Fig.1-14 Forward Current Vs Relative Intensity 正向电流与相对光强特性曲线

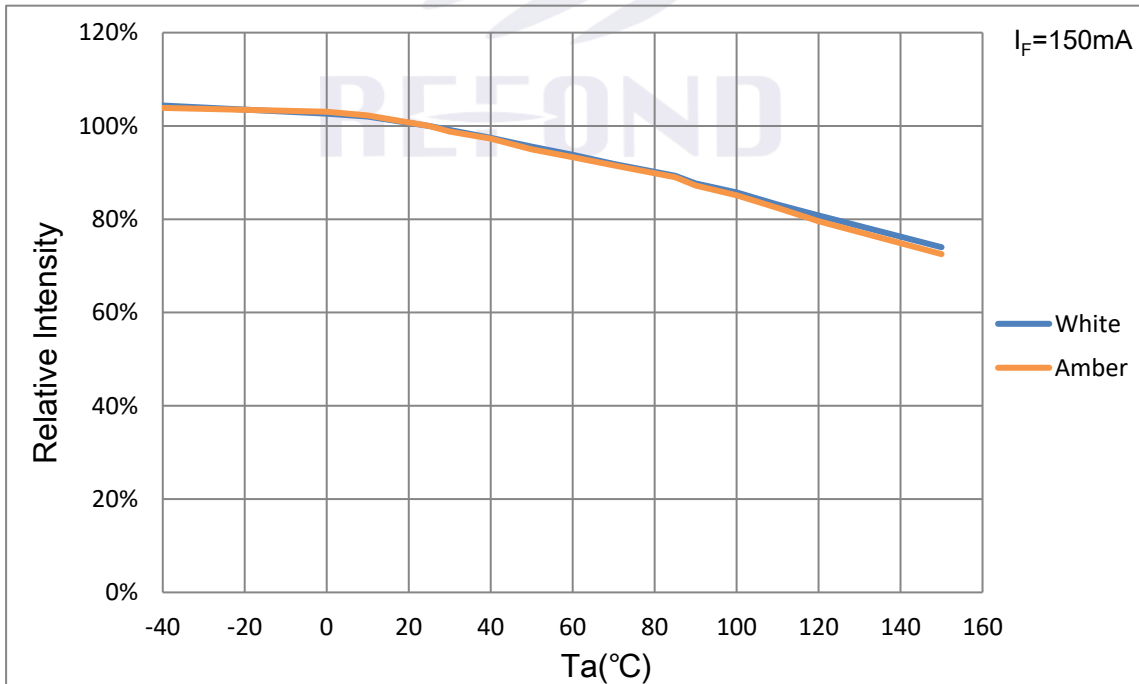

Fig.1-15 Ambient Temperature Vs Relative Intensity 环境温度与相对光强特性曲线

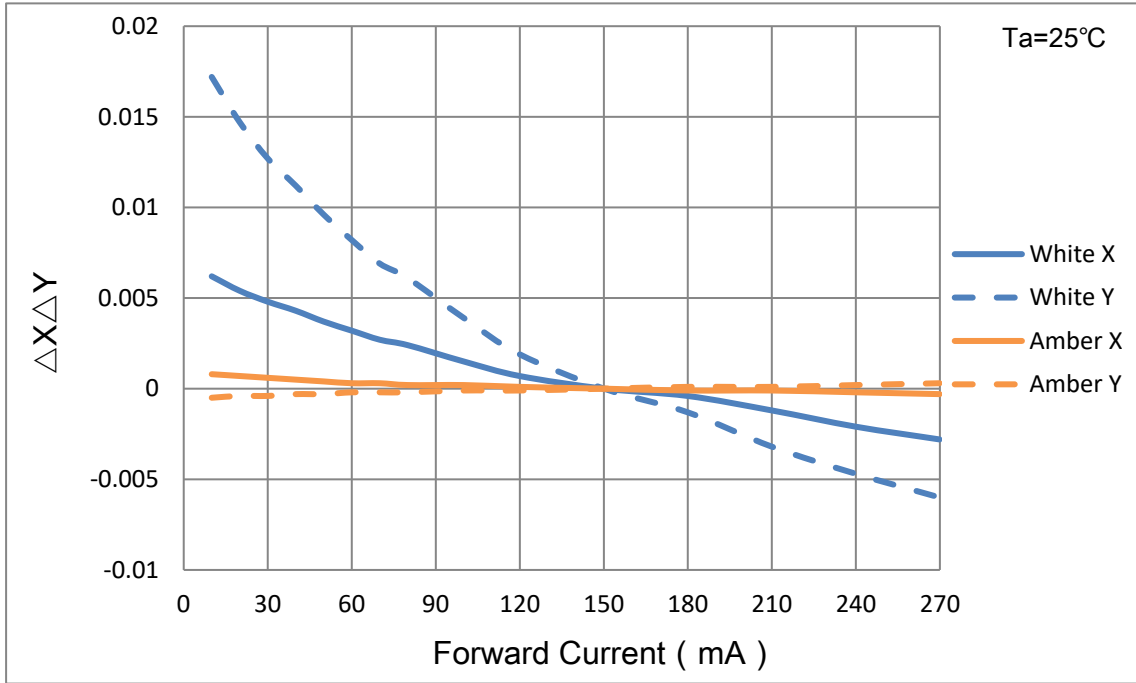

Fig.1-16 Forward Current vs. Color Shift 正向电流与色坐标偏移特性曲线

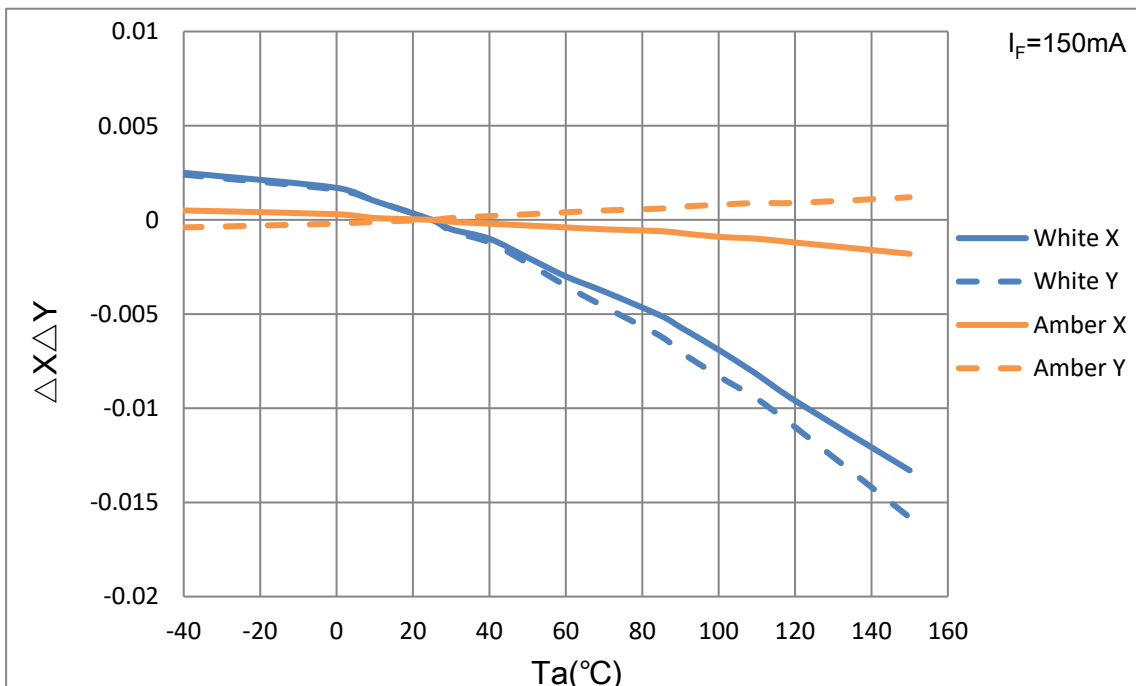

Fig.1-17 Ambient Temperature vs. Color Shift 环境温度与色坐标偏移特性曲线

2. Packaging 产品包装

2.1 Packaging Specification 包装规格

Package:2000pcs/reel.包装每卷 2000pcs。

2.1.1 Carrier Tape Dimension 载带尺寸

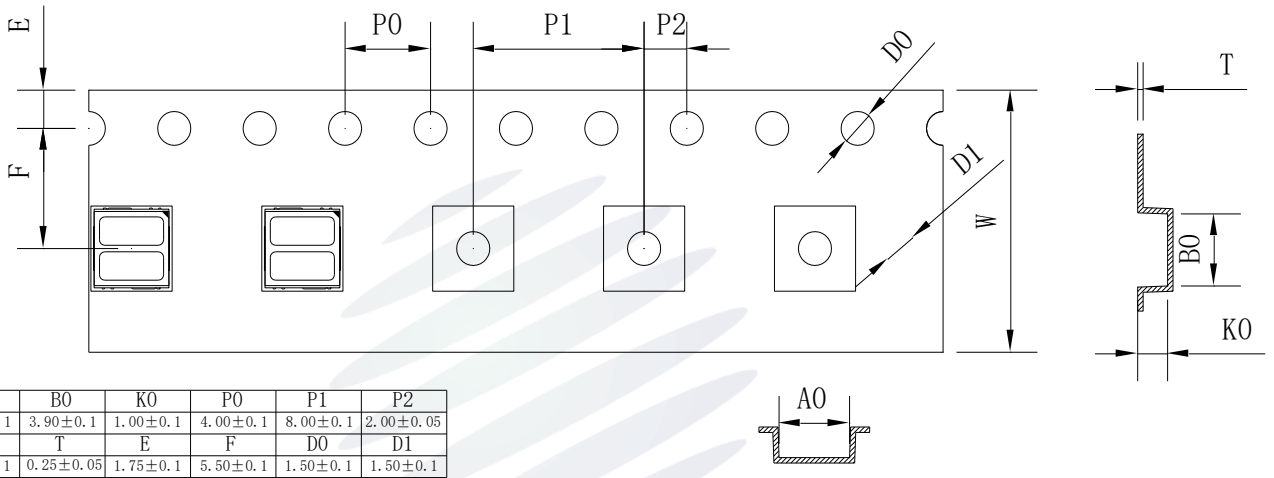

Fig.2-1 Carrier Tape Dimension 载带尺寸

2.1.2 Reel Dimension 卷盘尺寸

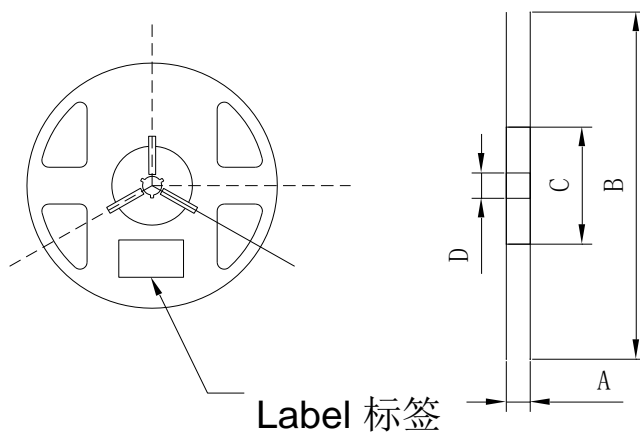

Fig.2-2 Reel Dimension 卷盘尺寸

Table 2-1 Reel Dimension 卷盘尺寸

A	13.6±0.1mm
B	180.0±1.0mm
C	60.0±1.0mm
D	13.0±0.5mm

Notes 备注:

The tolerances unless mentioned $\pm 0.10\text{mm}$. Unit : mm 注：未注公差为 ± 0.10 毫米，尺寸单位：毫米。

2.1.3 Label Form Specification 标签规格

(P) CUSTOMER P/N XXXXXXXXXX

(1P) MFG P/N RF-A3E31-W66E-A8-H0-PB-VM5

(Q) QUANTITY 4000

(D) D/C 2201 BIN: PBVM5

(L) LOT SC18-220908061



MSL:2
RoHS

Table 2-2 Specification 规格

CUSTOMER P/N	CUSTOMER NUMBER 客户编码
MFG P/N.	Manufacture Part Number 制造品名料号
QUANTITY.	QUANTITY 数量
D/C	Date Code 日期代码
BIN	Bin Code 参数代码
LOT	LOT NO.批次号
MSL:2	Moisture Sensitivity Levels 防潮等级

Fig. 2-3 Label Form Specification 标签规格

2.1.4 Part number nomenclature describe 产品型号描述

RF - A3E35 - 2W2 E - B1
 ① ② ③ ④ ⑤

- ① Company abbreviation: Refond 公司简称：瑞丰。
- ② Package type: A3 stands for gold plated product + Zener diode, E35 stands for round cup cut EMC 3537 封装类型：A3 表示镀金产品+齐纳二极管，E35 表示落料 EMC 3537。
- ③ Color type: 2W2 stands for white+Amber Double color 颜色类型：2W2 表示白光+琥珀光双色。
- ④ Rated current: E stands for rated current 150mA；额定电流：E 表示额定电流 150mA。
- ⑤ Chip type: A9 stands for the type of chip；芯片类型：B1 表示芯片类型。

2.2 Moisture Resistant Packing 防潮包装

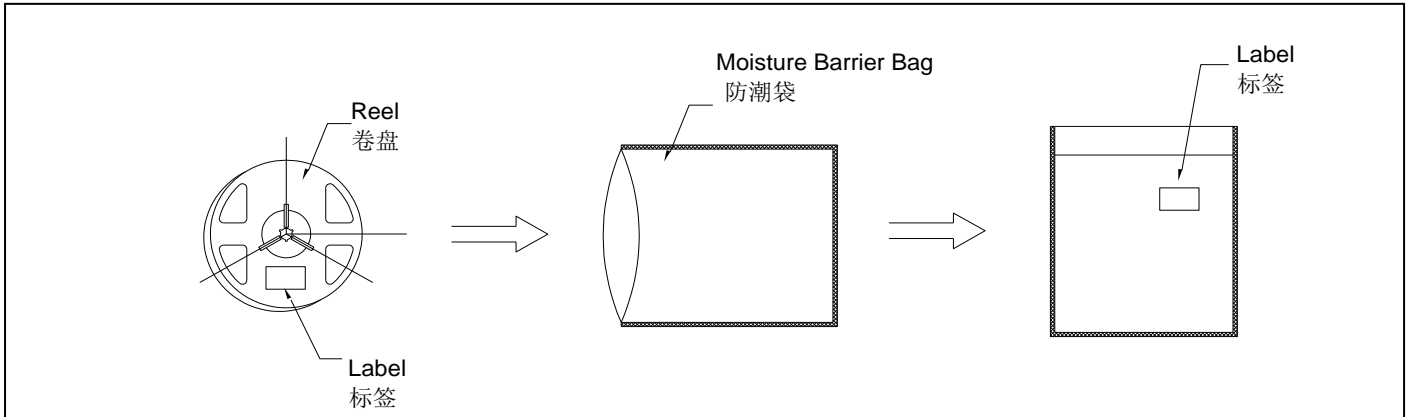

Fig.2-4 Moisture Resistant Packing 防潮包装

2.3 Cardboard Box 包装纸箱

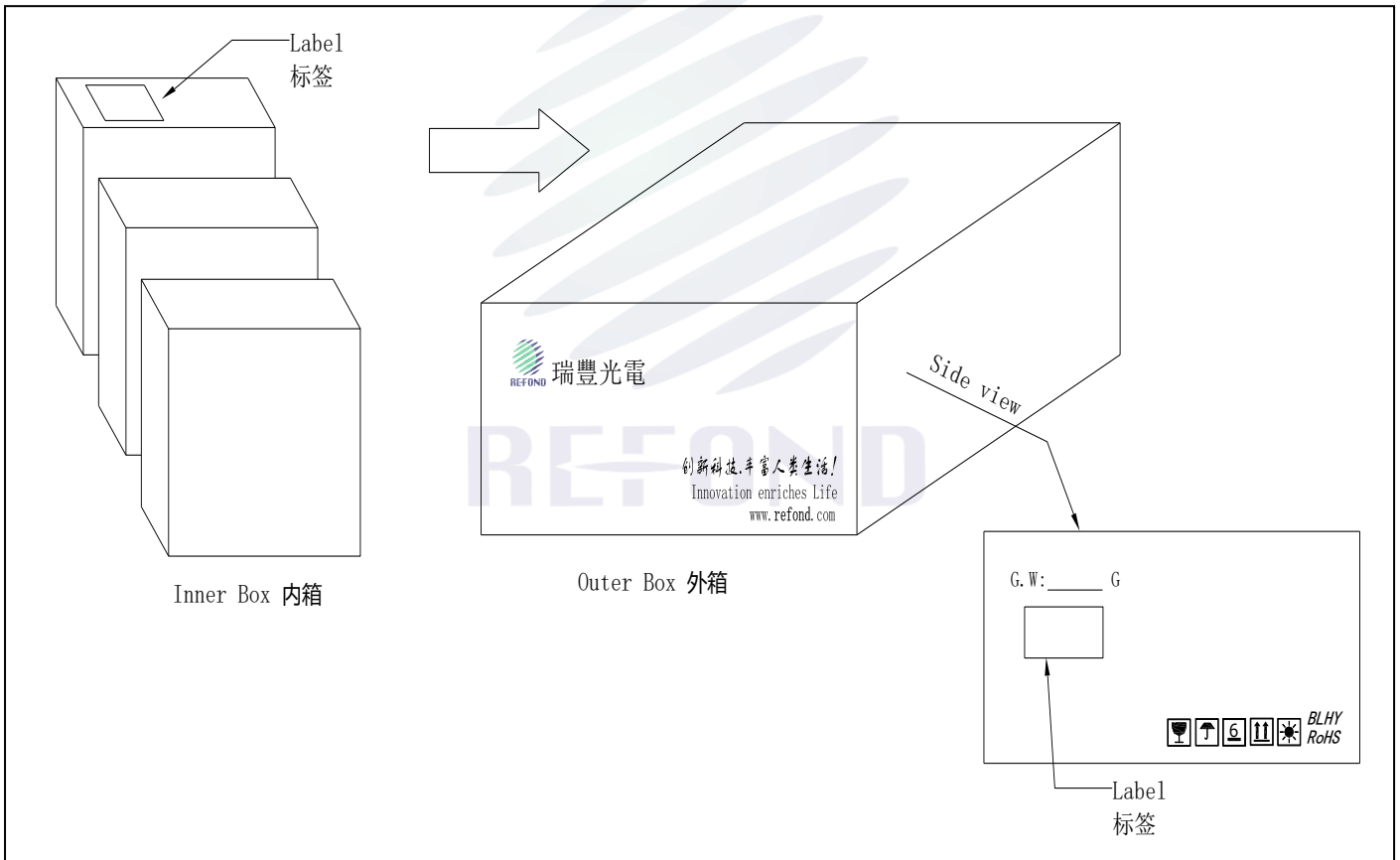

Fig.2-5 Cardboard Box 包装纸箱

Notes 备注:

1. One inner box fits in 5 packs product. 内箱可装 5 包产品。
2. The size of outer box is determined by deliver product amounts, the biggest size of outer box can fits in 14 inner boxes. 外箱尺寸由运送产品的数量决定, 最大尺寸的外箱可装 14 盒内箱。

3. SMT Reflow Soldering Instructions SMT 回流焊说明

3.1 SMT Reflow Soldering Instructions SMT 回流焊说明

Product complies to MSL Level 2 acc.to JEDEC J-STD-020E

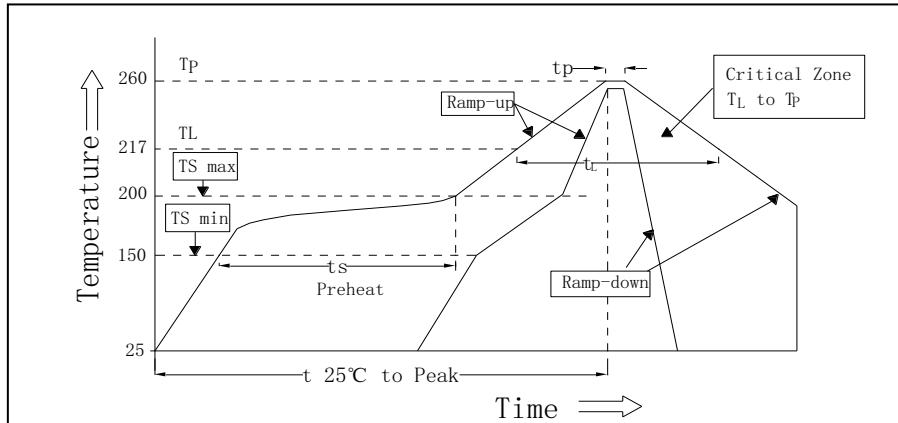

Fig.3-1SMT Reflow Soldering Instructions SMT 回流焊说明

Table 3-1Reflow parameters 回流焊参数

Profile Feature	Symbol	Minimum	Pb-Free(SnAgCu) Assembly	Maximum	Unit
Ramp-up rate to preheat 25°C to 150 °C			2	3	°C /s
Time t_s T_{smin} to T_{smax}	t_s	60	100	120	s
Ramp-up rate to peak T_{smax} to T_p			2	3	°C /s
Time limited to maintain high temperature	T_L		217		°C
Time limited to maintain high temperature	t_L		80	100	s
Peak /Classification of temperature	T_p		245	260	°C
Time within 5°C of the specified peak	t_p	10	20	30	°C
Ramp-down rate to preheat 25°C to 150 °C			3	6	°C /s
Time 25°C to T_p				480	s

Notes 备注:

(1) Reflow soldering should not be done more than twice. If more than 24 hours between the two soldering, LED will be damaged. 回流焊次数不可以超过两次，两次回流焊的时间间隔如果超过24小时，LED可能由于吸湿而损坏。

(2) When soldering, do not put stress on the LEDs during heating. 当焊接时，不要在材料受热时用力压胶体表面。

3.1.1 Cautions 注意事项

(1) The encapsulated material of the LEDs is silicone. Therefore the LEDs have a soft surface on the top of package. The pressure to the top surface will be impacted on the reliability of the LEDs. Precautions should be taken to avoid the strong pressure on the encapsulated part. So when use the picking up nozzle, the pressure on the silicone resin should be proper. Use the nozzle recommend by Refond, Please confirm the installation conditions of nozzle before using. LED封装胶为硅胶，表面较软，用力按压胶体表面会影响LED可靠性，因此应有预防措施避免在按压器件，当使用吸嘴时，胶体表面的压力应是恰当的。请使用瑞丰推荐的吸嘴，并在使用前确认吸嘴的安装条件。

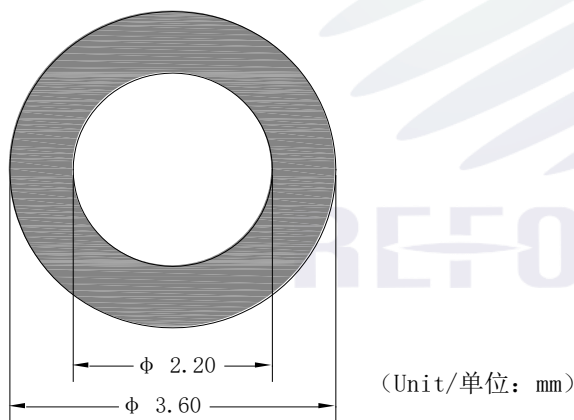

(2) Components should not be mounted on warped (non coplanar) portion of PCB. After soldering, do not warp the circuit board. LED灯珠不要焊接在弯曲的PCB板上，焊接之后，也不要弯折线路板。

(3) Do not apply mechanical force or excess vibration during the cooling process to normal temperature after soldering. Do not rapidly cool device after soldering. 回流焊之后冷却过程中，不要对材料施加外力，也不要震动，回流焊后，不要采用激剧冷却的方式。

(4) Recommended Nitrogen as atmosphere during the reflow. 使用回流焊时，推荐使用氮气回流焊。

4. Handling Precautions 产品使用注意事项

4.1 Handling Precautions 产品使用注意事项

(1) LED operating environment and sulfur element composition cannot be over 100PPM in the LED mating usage material. This is provided for informational purposes only and is not a warranty or endorsement. LED 工作环境及与 LED 适配的材料中硫元素及化合物成份不可超过 100PPM. 这只是一个建议，不作任何品质担保。

(2) In order to prevent external material from getting into the inside of LED, which may cause the malfunction of LED. According to IEC 61249-2-21, the single content of Bromine element is required to be less than 900PPM, the single content of Chlorine element is required to be less than 900PPM, the total content of Bromine element and Chlorine element in the external materials of the application products is required to be less than 1500PPM. This is provided for informational purposes only and is not a warranty or endorsement. 为了防止外界物质进入 LED 内部以造成 LED 的损伤，所处环境及所用套件等等，根据电子元器件无卤素环保标准（IEC 61249-2-21），单一的溴元素含量要求小于 900PPM，单一氯元素含量要求小于 900PPM，溴元素与氯元素总含量必须小于 1500PPM. 这只是一个建议，不作任何品质担保。

(3) VOCs (Volatile organic compounds) emitted from materials used in the construction of fixtures can penetrate silicone encapsulants of LEDs and discolor when exposed to heat and photonic energy. The result can be a significant loss of light output from the fixture. Knowledge of the properties of the materials selected to be used in the construction of fixtures can help prevent these issues. Refond advises against the use of any chemicals or materials that have been found or are suspected to have an adverse affect on device performance or reliability. To verify compatibility, Refond recommends that all chemicals and materials be tested in the specific application and environment for which they are intended to be used. Attaching LEDs, do not use adhesives that outgas organic vapor. 应用套件中的挥发性物质会渗透到 LED 内部，在通电产生光子及热的条件下，会导致 LED 变色，进而造成严重光衰，提前了解套件材料能够避免产生这些问题。瑞丰反对使用任何对 LED 器件的性能或者可靠性有害的物质或材料，不管这些材料是已经证实了的还是仅仅怀疑有害。针对特定的用途和使用环境，瑞丰建议对所有的物质和材料进行相容性的测试。在贴装 LED 时候，不要使用能产生有机挥发性气体的粘结剂。

(4) Handle the component along the side surface by using forceps or appropriate tools; Do not directly touch or Handle the silicone lens surface, it may damage the internal circuitry. 通过使用适当的工具从材料侧面夹取，不可直接用手或尖锐金属压胶体表面，它可能会损坏内部电路。

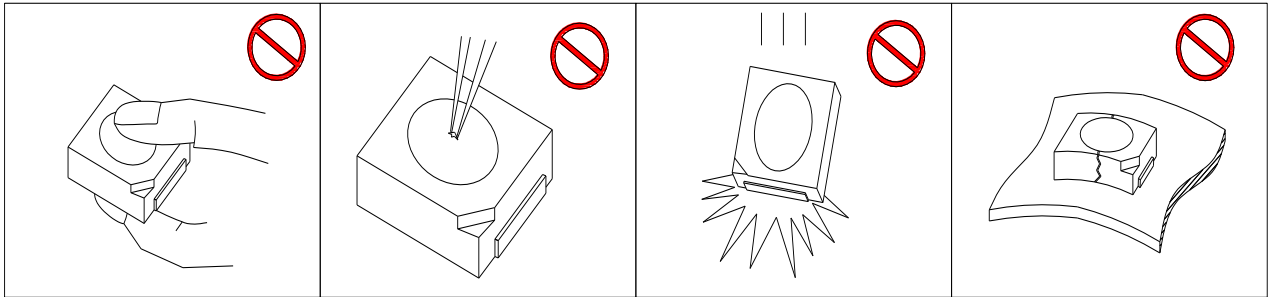

Fig 4-1 Cautions 注意事项

(5) In designing a circuit, the current through each LED can not exceed the absolute maximum rating specified for each LED. In the meanwhile, resistors for protection should be applied, otherwise slight voltage shift will cause big current change, burn out may happen. The driving circuit must be designed to allow forward voltage only when it is ON or OFF. If the reverse voltage is applied to LED, migration can be generated resulting in LED damage. 设计电路时，通过 LED 的电流不能超过规定的最大值，同时，还需使用保护电阻，否则，微小的电压变化将会引起较大电流变化，可能导致产品损毁。电路设计必须保证只有在开启或者关闭的时候出现正向电压的变化，不要施加反压，否则会损坏 LED。

(6) Thermal Design is paramount importance because heat generation may result in the Characteristics decline, such as brightness decreased, Color change and so on. Please consider the heat generation of the LEDs when making the system design. LED 容易因为自身的发热和环境的温度改变而改变，温度升高会降低 LED 发光效率，影响发光颜色，所以在设计时应充分考虑散热问题。

(7) Compared to standard encapsulants, silicone is generally softer, and the surface is more likely to attract dust, requiring special care during processing. In cases where a minimal level of dirt and dust particles cannot be guaranteed, a suitable cleaning solution must be applied to the surface after the soldering of components. Refond suggests using isopropyl alcohol for cleaning. In case other solvents are used, it must be assured that these solvents do not dissolve the package or resin. Ultrasonic cleaning is not recommended. Ultrasonic cleaning may cause damage to the LED. 与其他封装胶相比，硅胶通常较软，表面易吸附脏物，应用时应特别注意，当对产品洁净度要求较高时，回流焊以后需要采用恰当的清洗方式，我们推荐用异丙醇作清洗剂，如需要用到其他清洗剂，必须保证不会破坏封装体，超声清洗可能会对 LED 带来损害，不推荐这种清洗方式。

Table 4-1 Storage 儲存

Recommended storage time 推荐储存时间 (Based on Refond product experience 基于瑞丰产品使用经验)

Conditions 种类		Temperature 温度	Humidity 湿度	Time 时间
Storage 储存	Before Opening Aluminum Bag 拆包前	≤30°C	≤75%	Within 1 Year From Date 一年内
	After Opening Aluminum Bag 拆包后	≤30°C	≤60%	Recommended for use within 24 hours 建议24小时内使用
Baking 烘烤		60±5°C	-	≥24hours 大于24小时

(8) If the moisture absorbent material (silica gel) has faded away or the LEDs have exceeded the storage time, baking treatment should be performed after unpacking and based on the following condition (60±5) °C for above 24 hours. 如果干燥剂或包装失效，或者产品不符合以上有效储存条件，需拆包后进行烘烤，烘烤条件：60±5°C，大于 24 小时。

If the package is flatulence or damaged, please notify the sales staff to assist. 如果包装胀气或者破损，请通知销售人员协助处理。

(9) Similar to most Solid state devices; LEDs are sensitive to Electro-Static Discharge (ESD) and Electrical Over Stress (EOS). 像其他的半导体电子器件一样，LED 对静电过流击穿非常敏感，需要做好防护。

- This LED is sensitive to transient excessive voltages (e.g. ESD, lightning surge). If this excessive voltage occurs in the circuit, it may cause the LED to be damaged causing issues (e.g. the LED to become dimmer or not to illuminate [i.e. catastrophic failure]). Ensure that when handling the LEDs, necessary measures are taken to protect them from an ESD discharge. The following examples are recommended measures to eliminate the charge:

该 LED 对瞬态过电压(如 ESD、雷击浪涌)非常敏感。如果电路中出现这种电压过高,它就会可能会导致 LED 损坏,引发问题(例如 LED 变暗或不亮,即灾难性的失败)。操作 LED 时,必须采取必要的措施防止静电放电。以下是消除静电的建议措施:

- ① Grounded wrist strap, ESD footwear, clothes, and floors 防静电腕带、防静电鞋、防静电服、防静电地板
 - ② Grounded workstation equipment and tools 工作站设备和工具接地
 - ③ ESD table/shelf mat made of conductive materials 由导电材料制成的防静电桌/架垫
- Ensure that all necessary measures are taken to prevent the LEDs from being exposed to transient excessive voltages (e.g. ESD, lightning surge):

确保采取了所有必要的措施,以防止 LED 暴露在瞬态过度电压(如 ESD, 雷电冲击波):

- ① tools (e.g. soldering irons), jigs, and machines that are used are properly grounded
所使用的工具(如烙铁)、夹具和机器应正确接地
 - ② appropriate ESD materials/equipment are used in the work area
在工作区域使用适当的 ESD 材料/设备
 - ③ the system/assembly is designed to provide ESD protection for the LEDs.
该系统/组件旨在为 led 提供 ESD 保护。
- If the tool/equipment used is an insulator (e.g. glass cover, plastic, etc.), ensure that necessary measures have been taken to protect the LED from transient excessive voltages (e.g. ESD). The following examples are recommended measures to eliminate the charge:

如果使用的工具/设备是绝缘体(如玻璃罩、塑料等),确保已采取必要措施保护 LED 免受瞬态过电压(例如 ESD)。下面的例子是建议消除静电的措施:

- ① Dissipating static charge with conductive materials 利用导电材料消散静电
 - ② Preventing charge generation with moisture 防止水分产生电荷
 - ③ Neutralizing the charge with ionizers 用电离子器中和电荷
- To detect if an LED was damaged by transient excess voltages (i.e. an ESD event during the system's assembly process), perform a characteristics inspection (e.g. forward voltage measurement, light-up test) at low current ($\leq 1\text{mA}$).

要检测 LED 是否因瞬态过度电压(即系统组装过程中的 ESD 事件)而损坏,请执行在小电流($\leq 1\text{mA}$)下的特性检查(如正向电压测量、亮灯测试)。

- Failure Criteria: $V_F < 2.0\text{V}$ at $I_F = 0.5\text{mA}$ 故障标准: $I_F = 0.5\text{mA}$ 时 $V_F < 2.0\text{V}$
If the LED is damaged by transient excess voltages (e.g. ESD), it will cause:

如果 LED 被瞬态过电压损坏(例如 ESD),将会导致:

- ① the Forward Voltage (VF) to decrease. 正向电压(VF)降低



Declare 申明

This specification is written both in English and in Chinese and the latter is formal.
产品规格书以中英文方式书写，若有冲突以中文版本为准。